

SK NÁVOD NA MONTÁŽ  
 CZ MONTÁŽNÍ NÁVOD  
 HU SZERELÉSI UTASÍTÁS

# INVITA TYP 8

	905	mm
	400	
	905	

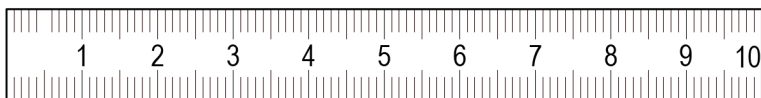

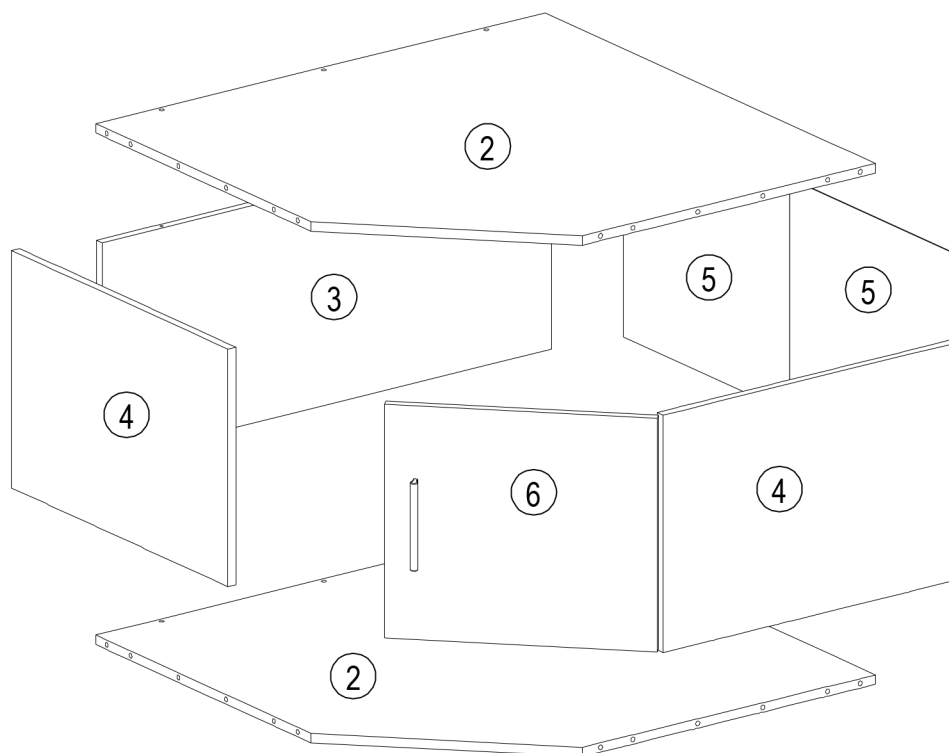
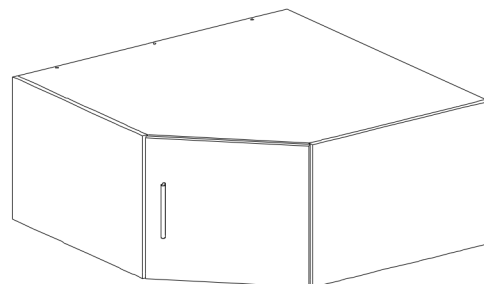



ID	ID	Part	Qty	Ratio
11600	②	886*886*16	2x	1/1
11601	③	366*886*16	1x	1/1
11580	④	400*580*16	2x	1/1
11611	⑤	394*446*2,5	2x	1/1
11582	⑥	394*438*16	1x	1/1

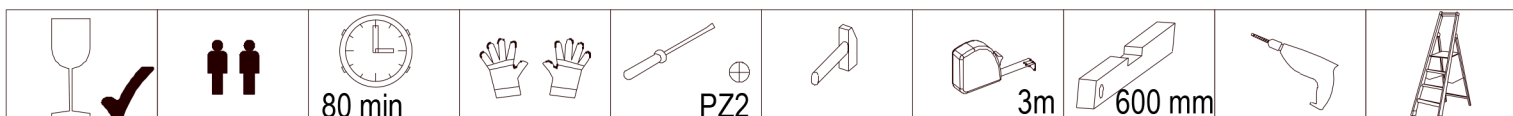
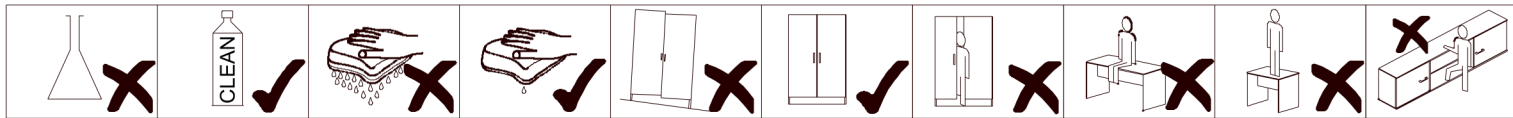
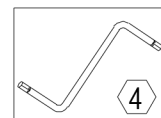

Ø3,5x15	Ø8x30				Ø1,2x20		Ø3,5x16	Ø8	Ø4x70
A 4x	B 16x	C 2x	D 8x	E 8x	G 50x	H 1x	J 2x	K 1x	L 1x

				Ø4x25	Ø7x50
M 8x	N 1x	P 2x	R 2x	S 2x	T 6x



						
A	B	D	E	N	P	S
4x	16x	8x	8x	1x	2x	2x

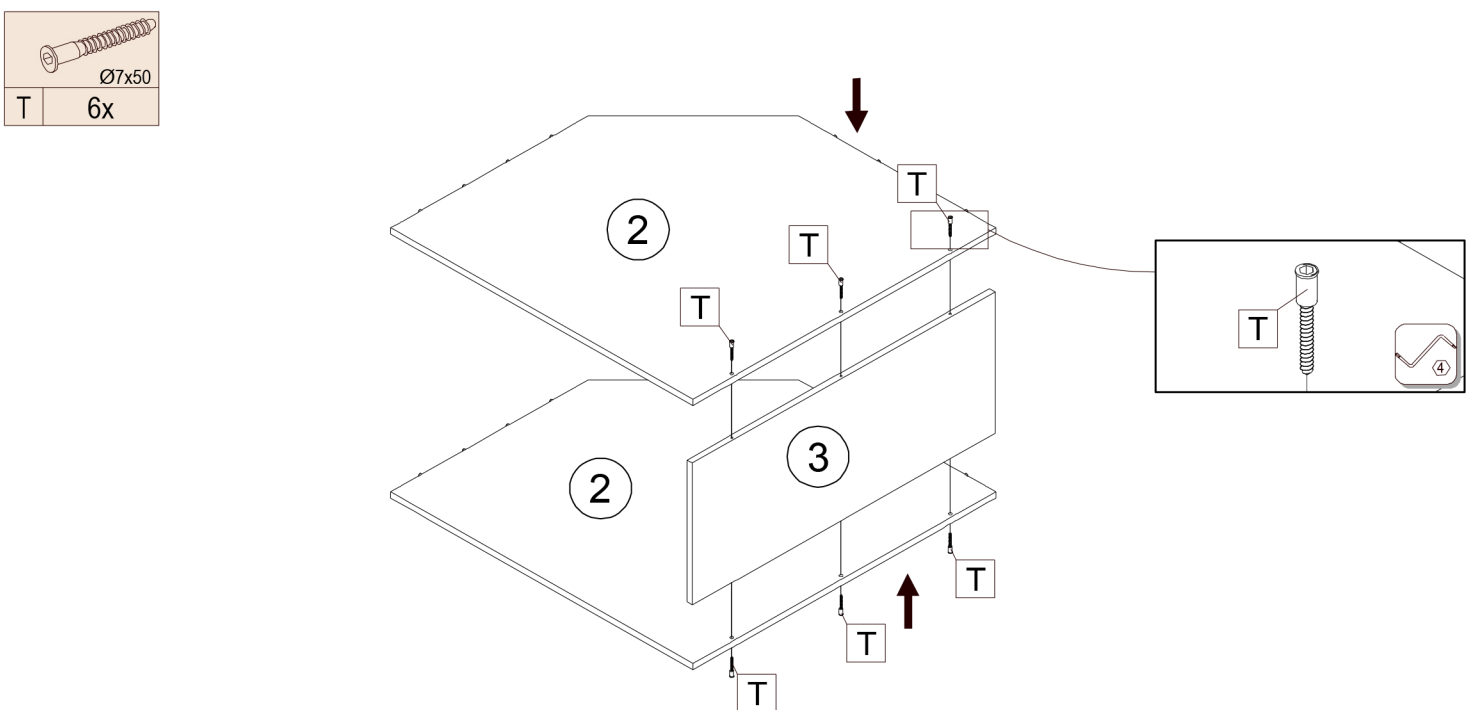
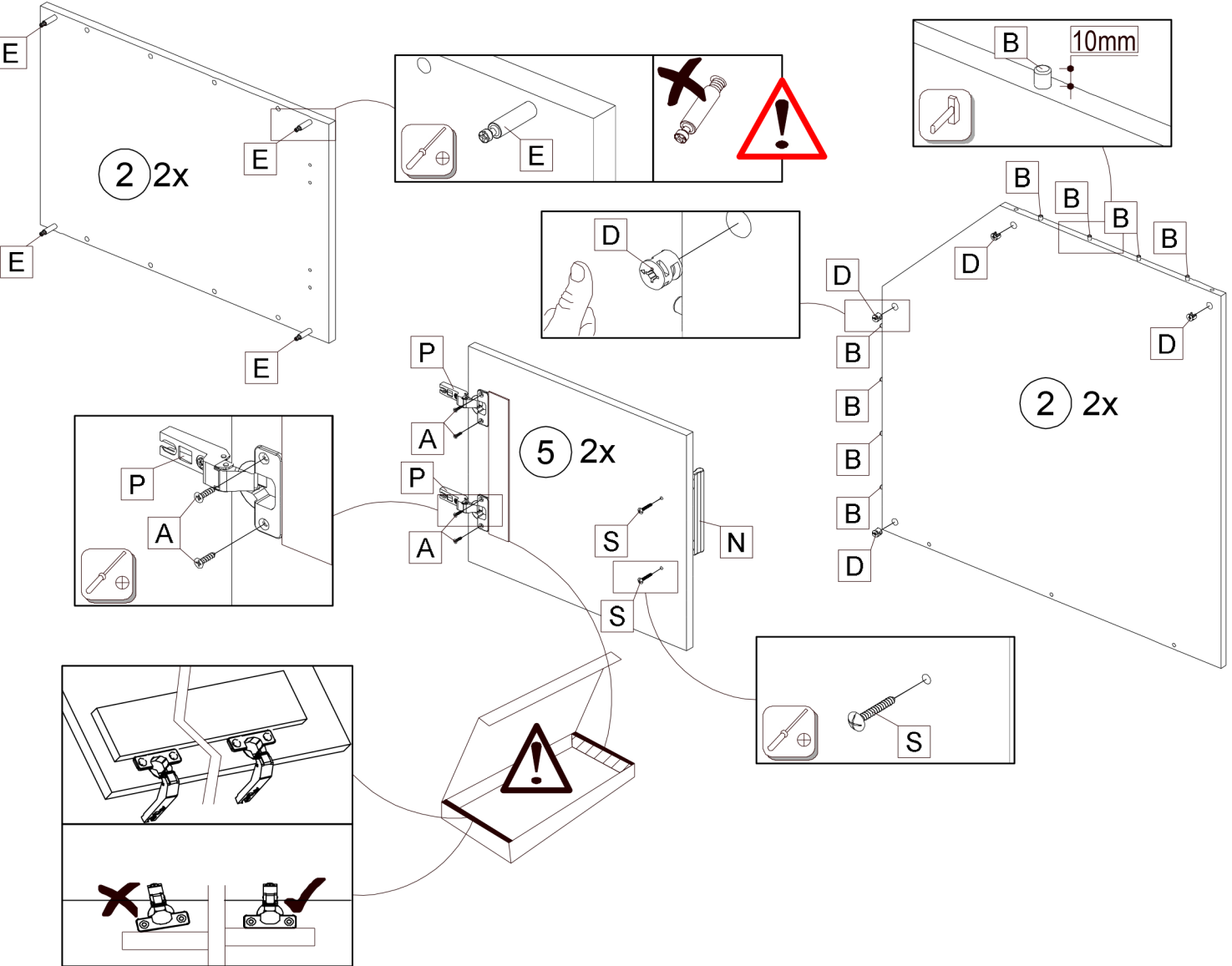

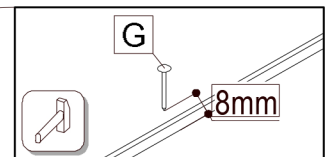
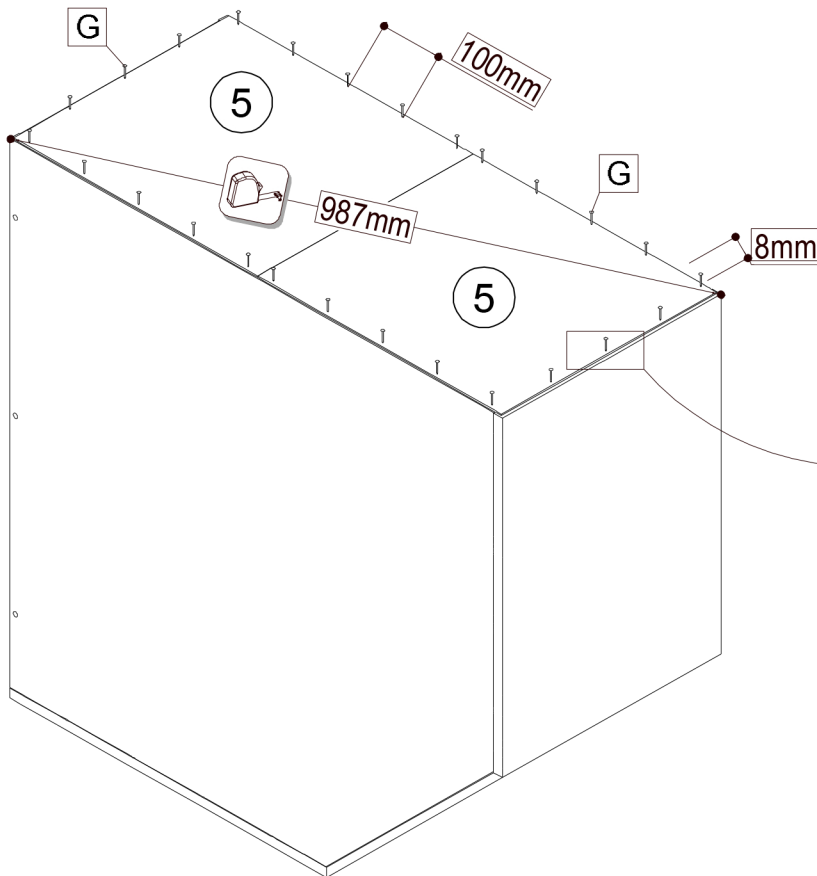
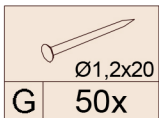
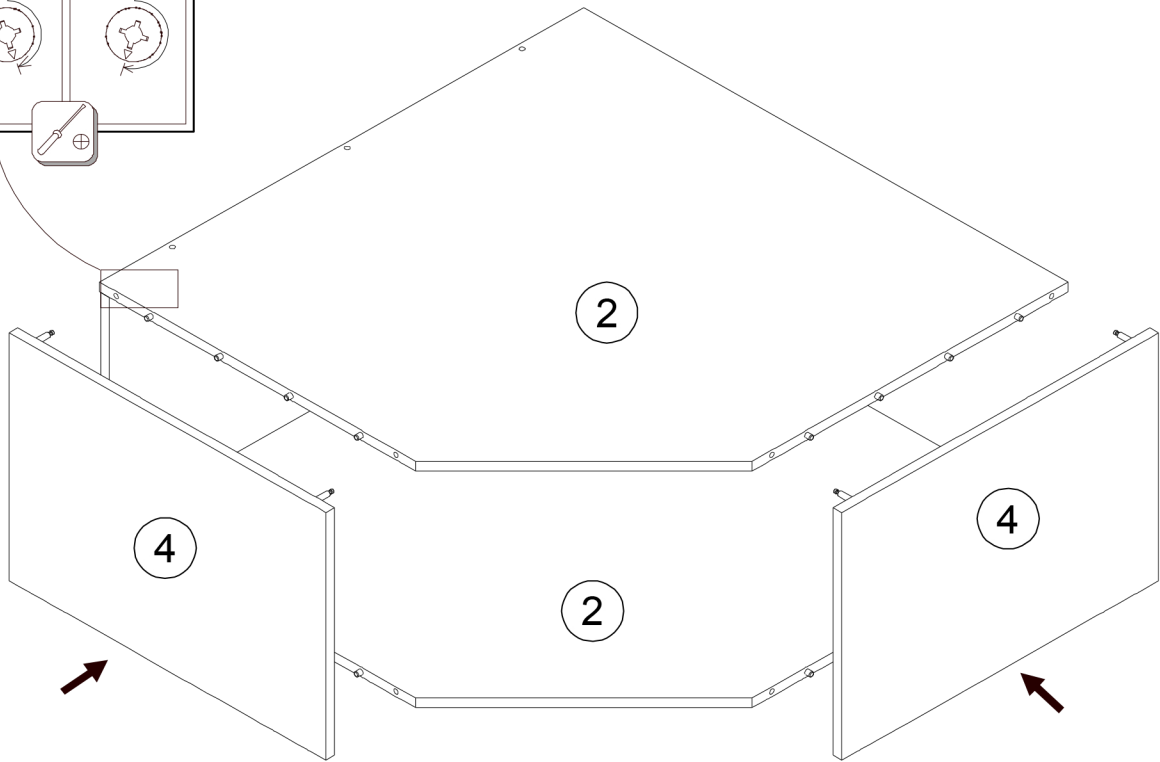
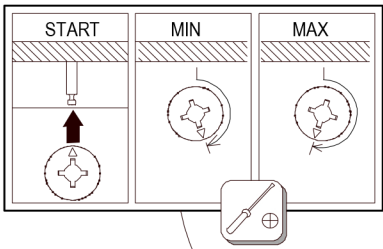

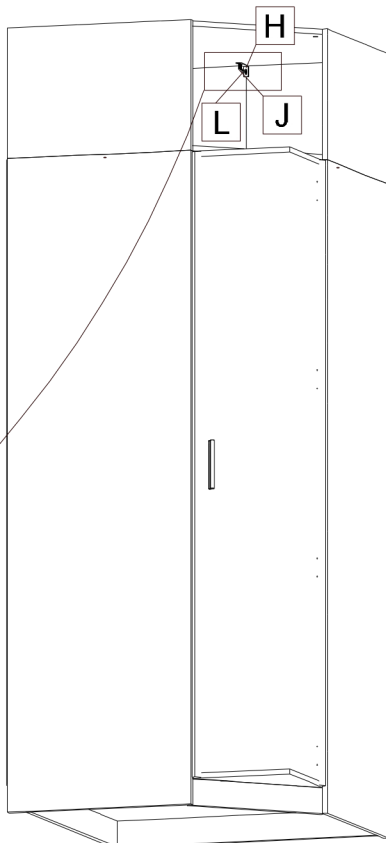
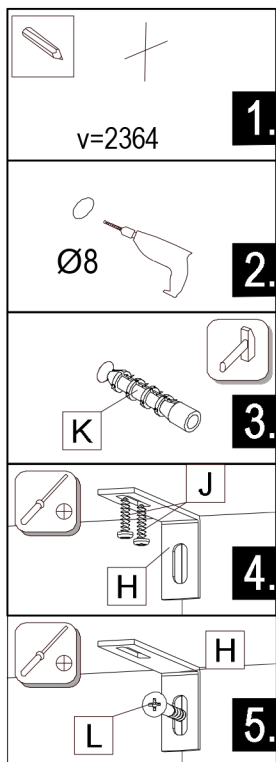
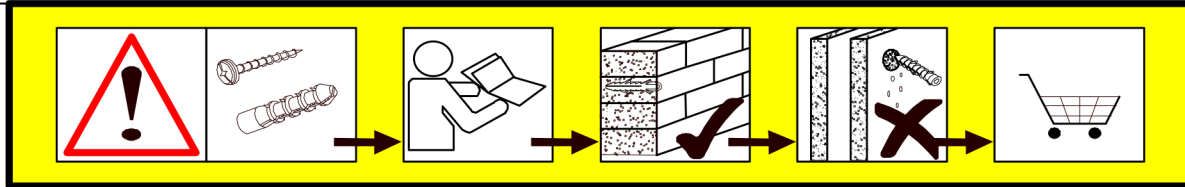
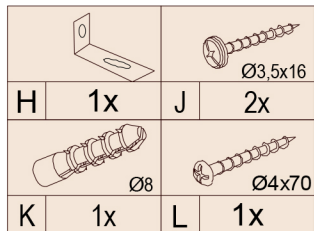
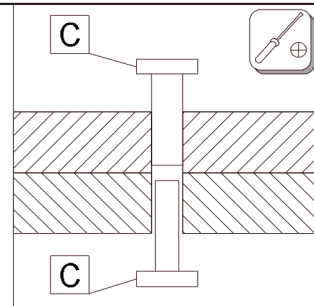
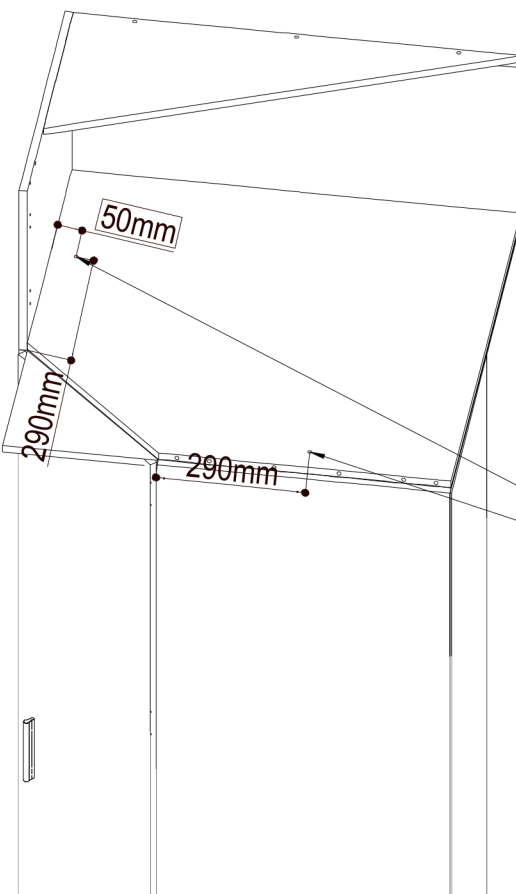
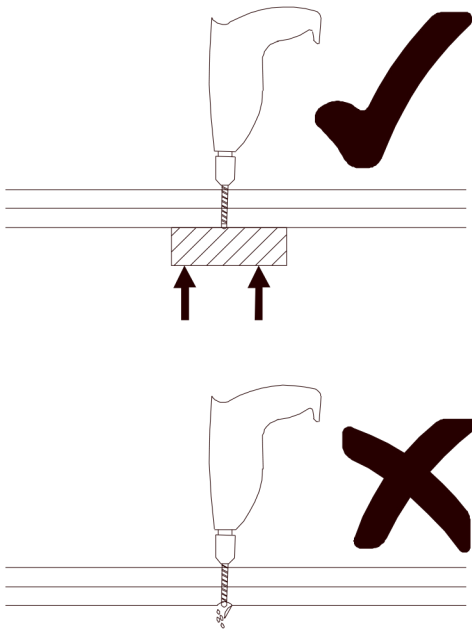
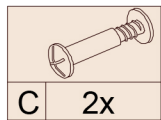

**SK**

Upozornenie! Pevnosť steny sa musí pred montážou bezpodmienečne skontrolovať. Univerzálne hmoždenky, ktoré sú obsiahnuté v balení, používajte jedine pre pevné murivo ako je betón/tehla. Hmoždenky sa nesmú používať v prípade ľahkého staveného muriva, dutina tehla, u sádkartónových dosiek alebo iných konštrukcií rámu. U týchto murív je nutné použiť špeciálne hmoždenky! Tieto je možné dostať v špeciálnych predajniach so stavebným materiálom (stavebniny). Pri nedodržaní pokynov nepreberajú výrobcovia/predajci a dodávateľa zodpovednosť za vzniknuté škody.

**HU**

Vigyázat! Szerelés előtt a falfelületet feltétlenül vizsgálja meg. A mellékelt univerzális tiplí kizárólag stabil falazathoz használható mint például beton/tégla. A fali tiplí nem használható könnyű építőkövek hez, üreg tégla, gipszkarton lapokhoz vagy más fávázás építményekhez. Ezekhez a falfelületekhez csak speciális tiplik használhatóak, melyek szaküzletekben (barkácsáruházakban) beszerezhetők. Fentiek figyelmen kívül hagyása esetén a gyártó/kereskedő vagy forgalmazó nem vállal felelősséget.

**CZ**

Upozornění! Před montáží je nutné zkontrolovat stav stěny. Příložené univerzální hmoždinky jsou určeny pouze k použití pro pevné zdivo jako beton/cihly. Hmoždinky do zdi se nesmí používat u dutinová cihla, zdiva jako pórovitý stavební kámen, sádkartónová deska nebo jiný měkký materiál. U těchto zdív jsou nutné použít speciální hmoždinky! Jsou k dostání v speciálních prodejnách se stavebním materiálem. Při nedodržení těchto pokynů výrobce/prodejce a dovozce neručí za způsobené škody.



R 2x

**P**

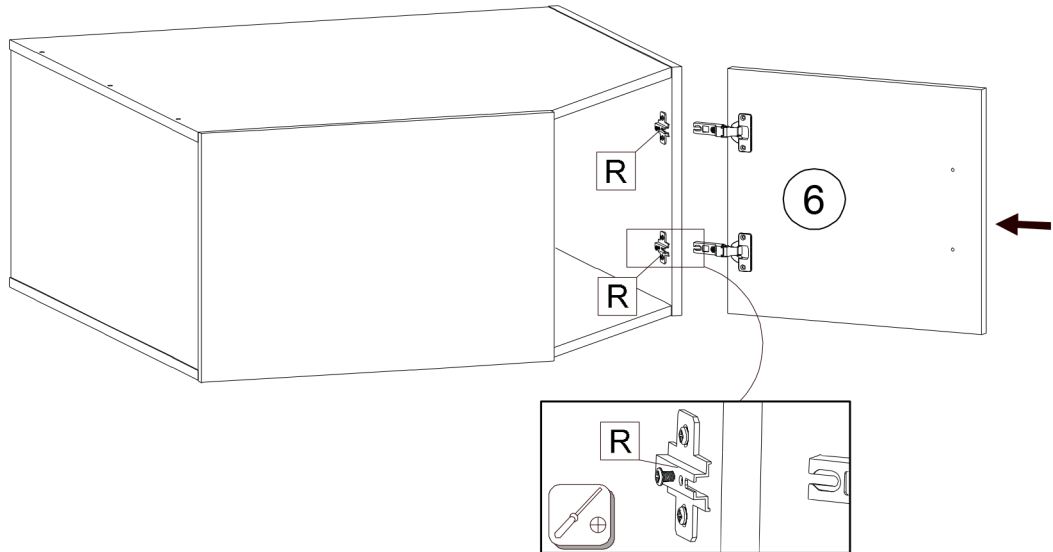

R 2x

**L**

