

SK NÁVOD NA MONTÁŽ  
 CZ MONTÁŽNÍ NÁVOD  
 HU SZERELÉSI UTASÍTÁS

# INVITA TYP 9

	900	mm
	400	
	600	

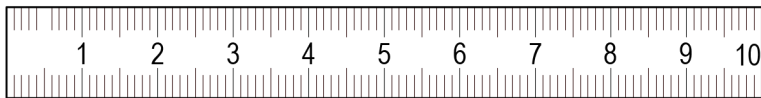

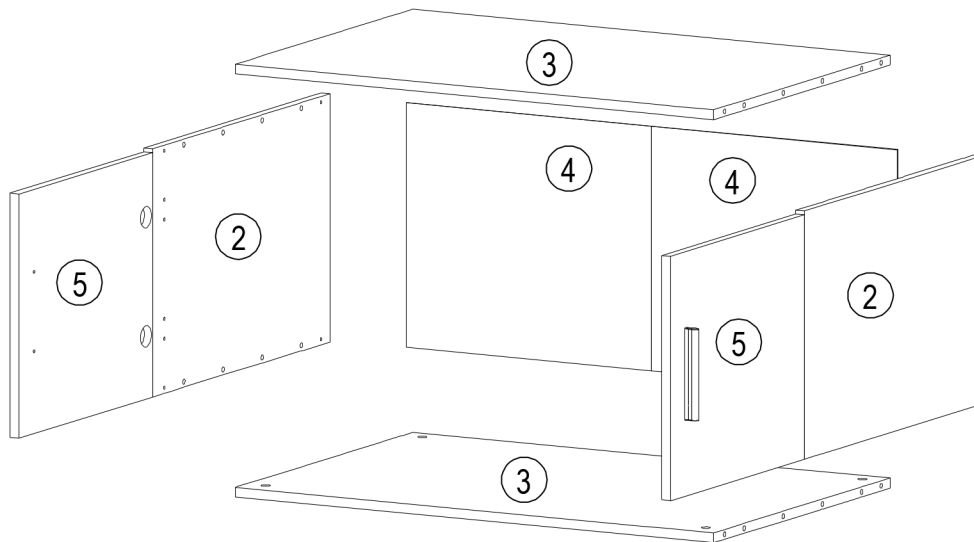
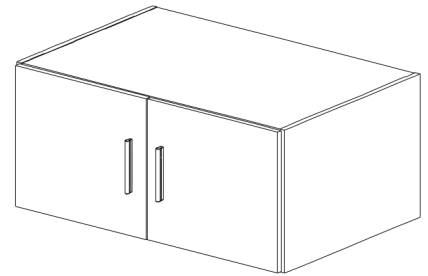



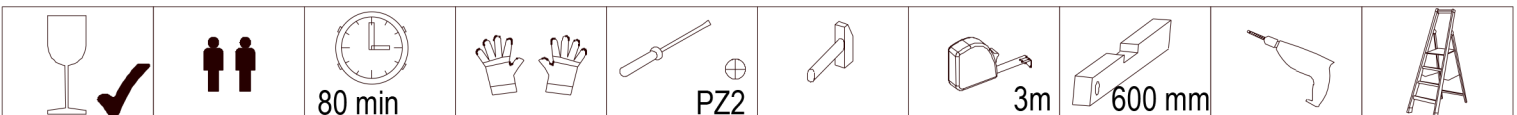
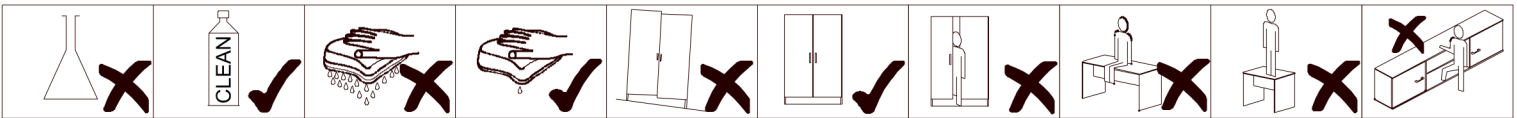

11580	②	400*580*16	2x	1/1
11583	③	868*579*16	2x	1/1
11611	④	394*446*2,5	2x	1/1
11582	⑤	394*438*16	2x	1/1





22243,00	27000,00	22601,00	70013,01	70021,01	21102,00	31103,00	22244,01	24103,00	22213,00
Ø3,5x15	Ø8x30				Ø1,2x20		Ø3,5x16	Ø8	Ø4x70
A 8x	B 16x	C 2x	D 8x	E 8x	G 50x	H 1x	J 4x	K 1x	L 1x

32030,00	36013,02	36013,02	22430,00	
Ø4x25				
M 8x	N 2x	P 4x	R 4x	S 4x

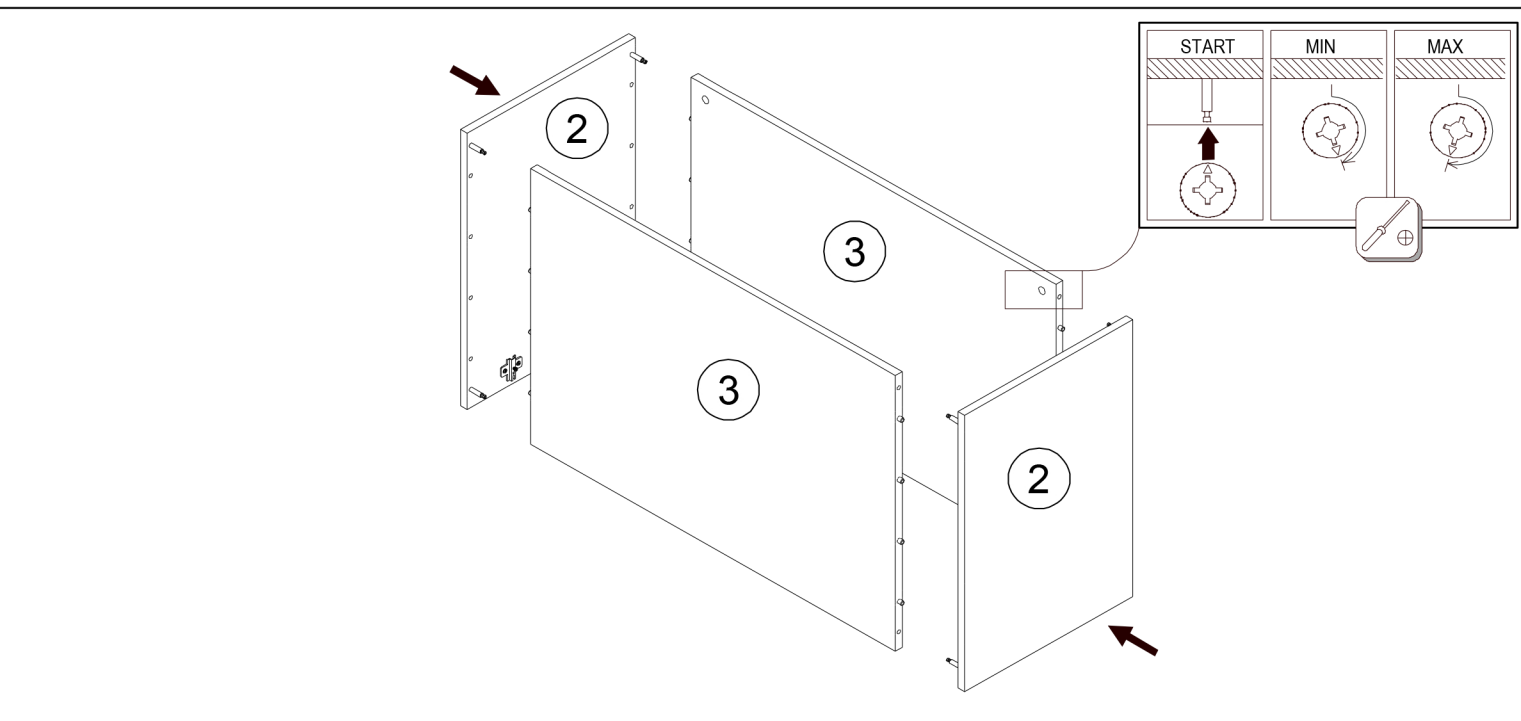
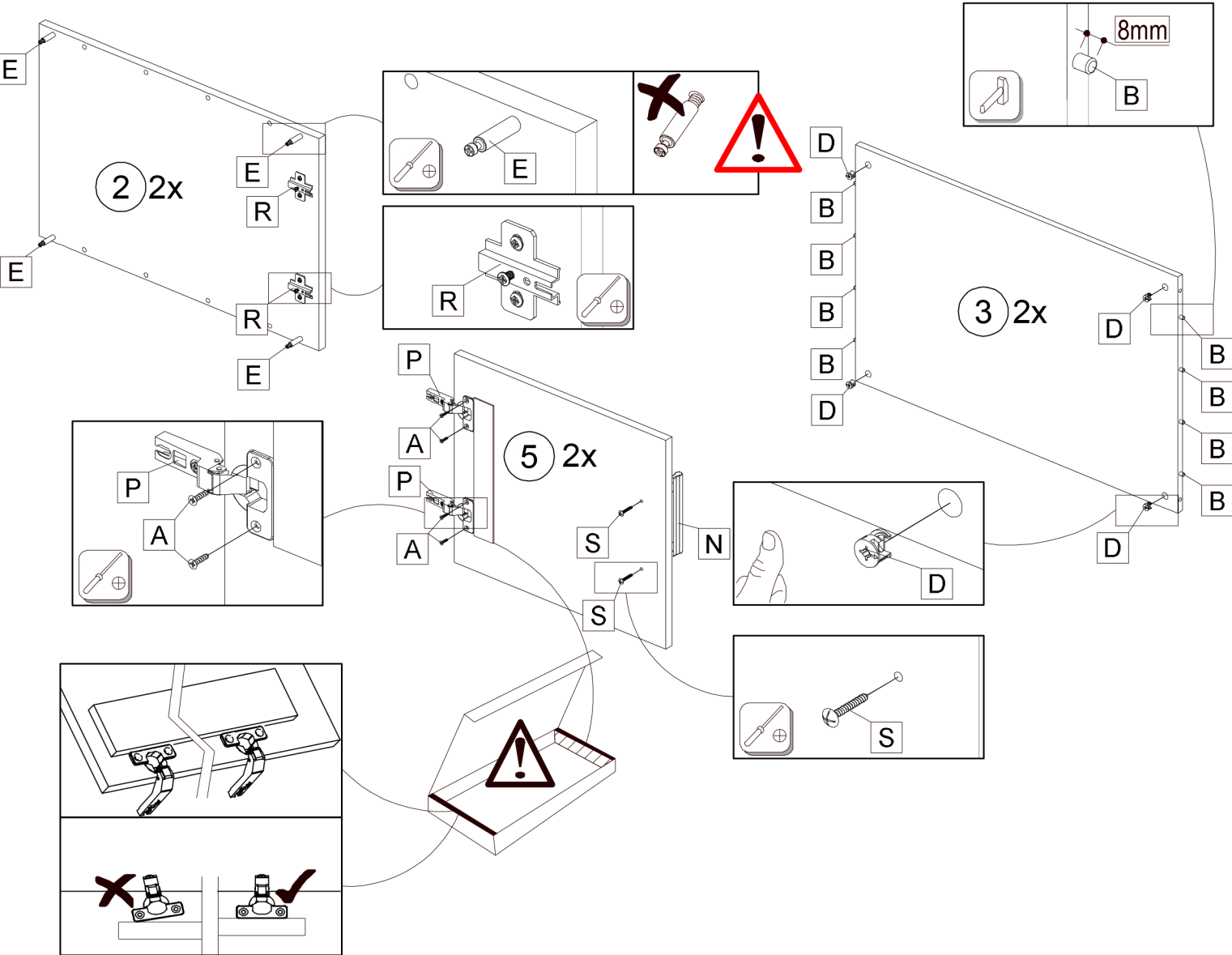

							
A	B	D	E	N	P	R	S
8x	16x	8x	8x	2x	4x	4x	4x





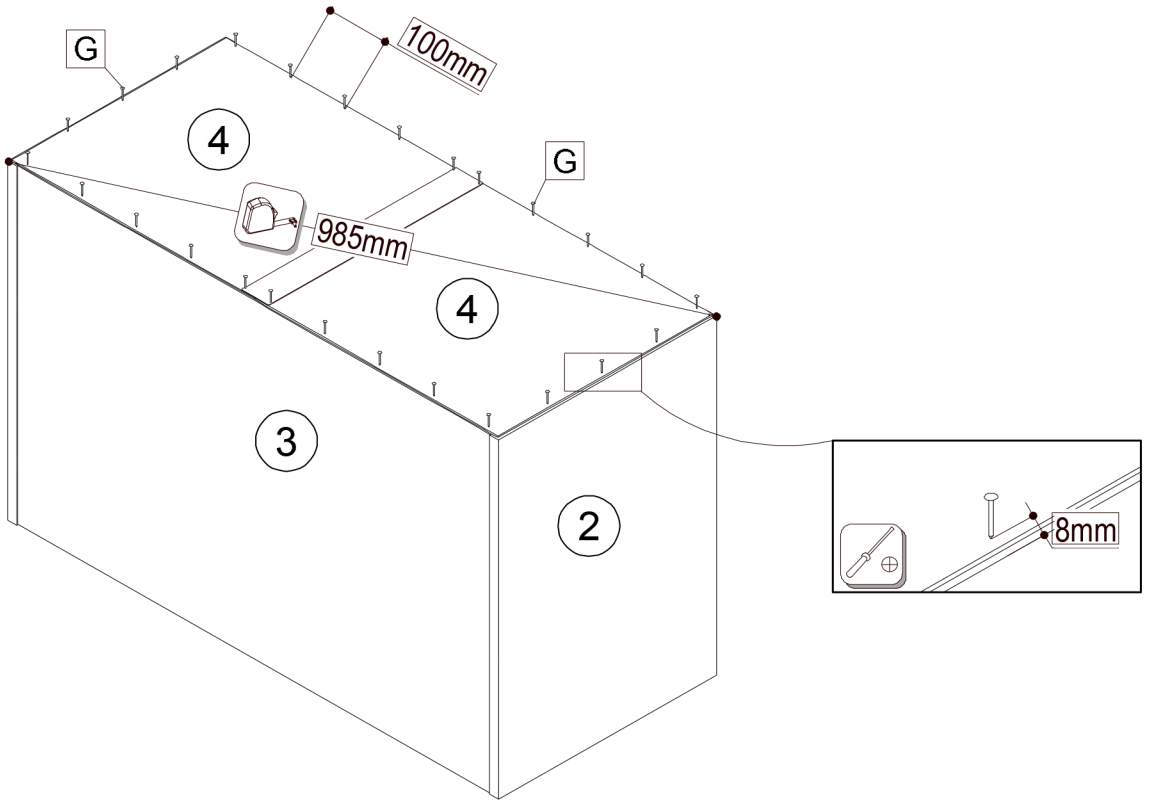

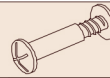
  
Ø1,2x20  
G 50x

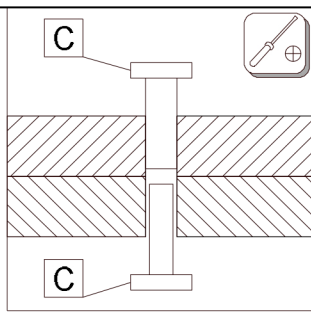
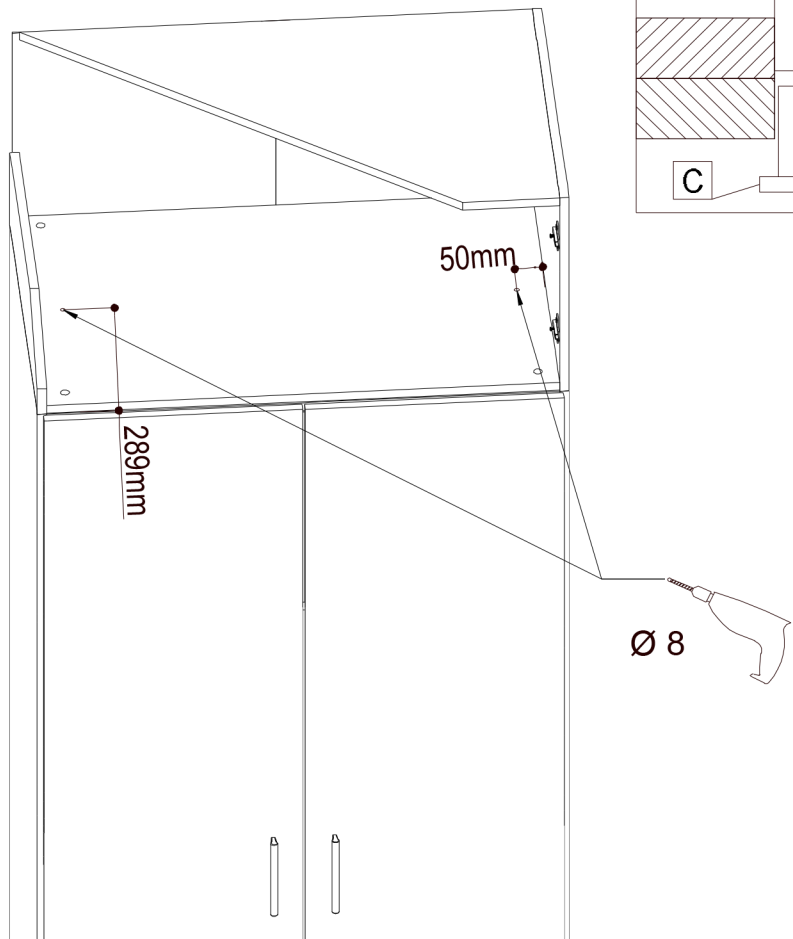
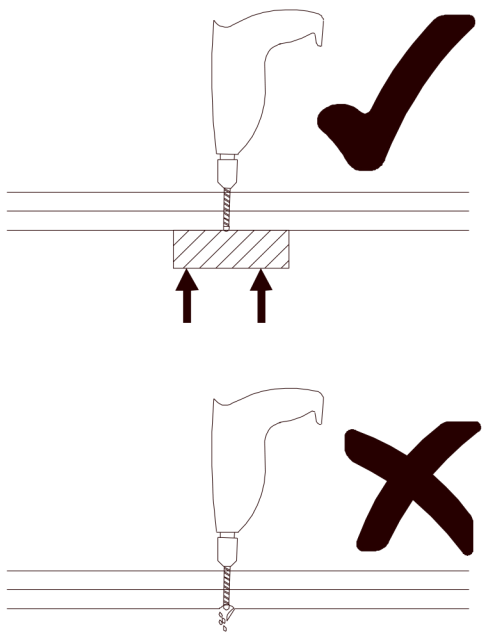

  
C 2x



	H	1x		J	2x
	K	1x		L	1x

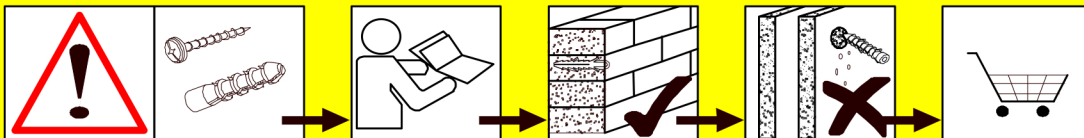
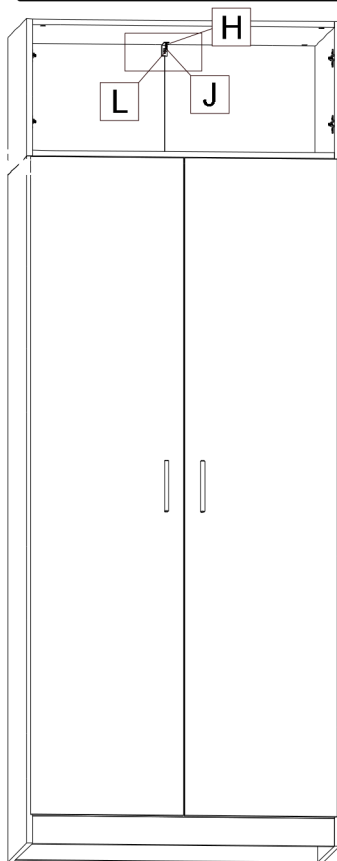
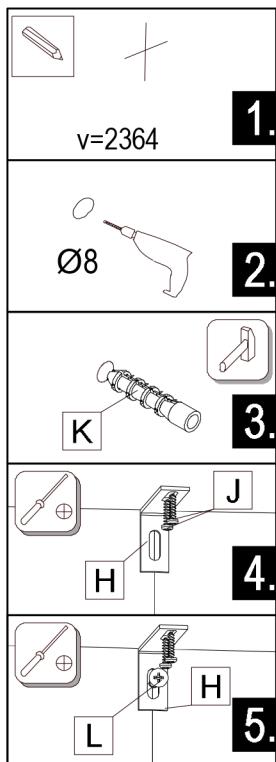

SK

Upozornenie! Pevnosť steny sa musí pred montážou bezpodmienečne skontrolovať. Univerzálne hmoždenky, ktoré sú obsiahnuté v balení, používajte jedine pre pevné mŕtvo ako je betón/tehla. Hmoždenky sa nesmú používať v prípade ľahkého stavebného mŕtva, dutina tehla, u sádkartónových dosiek alebo iných konštrukcií rámu. U týchto mŕtva je nutné použiť špeciálne hmoždenky! Tieto je možné dostať v špeciálnych predajniach so stavebným materiálom (stavebniny). Pri nedodržíaní pokynov nepreberajú výrobcovia/predajci a dodávateľia zodpovednosť za vzniknuté škody.

HU

Vigyázat! Szerelés előtt a falfelületet feltétlenül vizsgálja meg. A mellékelt univerzális tipli kizárólag stabil falazathoz használható mint például beton/tégla. A fali tipli nem használható könnyű építőkövek hez, üreg tégla, gipszkarton lapokhoz vagy más fávázás építményekhez. Ezekhez a falfelületekhez csak speciális tiplik használhatóak, melyek szaküzletekben (barkácsáruházakban) beszerezhetőek. Fentiek figyelmen kívül hagyása esetén a gyártó/kereskedő vagy forgalmazó nem vállal felelősséget.

CZ

Upozornění! Před montáží je nutné zkontrolovat stav stěny. Příložené univerzální hmoždinky jsou určeny pouze k použití pro pevné zdivo jako beton/cihly. Hmoždinky do zdi se nesmí používat u dutinová cihla, zdiva jako pórovitý stavební kámen, sádkartónová deska nebo jiný měkký materiál. U těchto zdív jsou nutné použít speciální hmoždinky! Jsou k dostání v speciálních prodejnách se stavebním materiálem. Při nedodržíaní těchto pokynů výrobce/prodejece a dovozce neručí za způsobené škody.

	M	8x
--	---	----

