

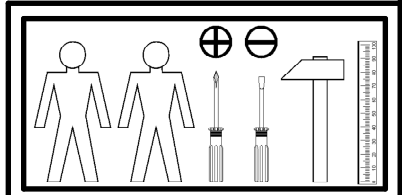

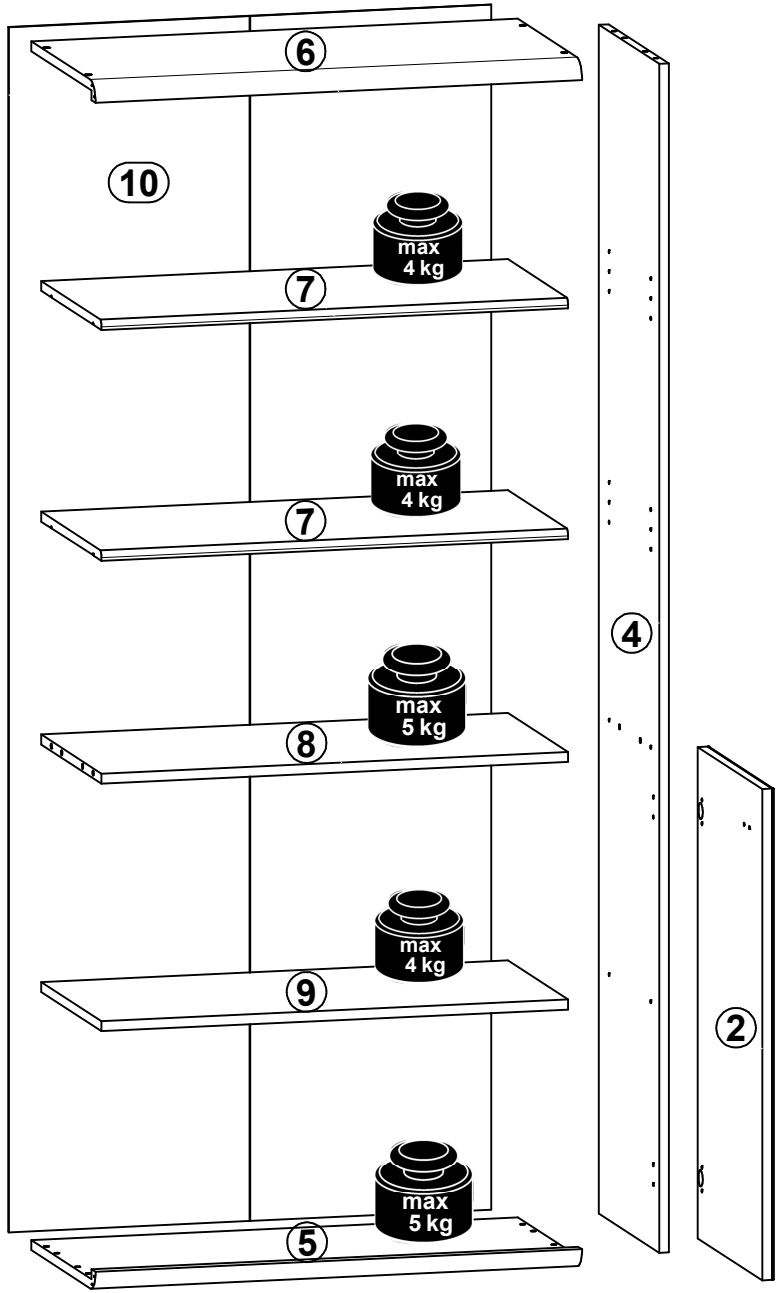

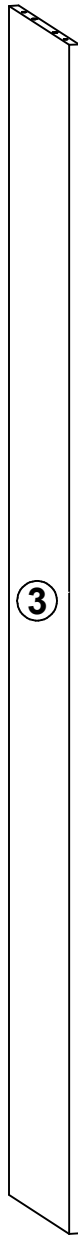

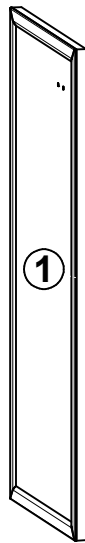

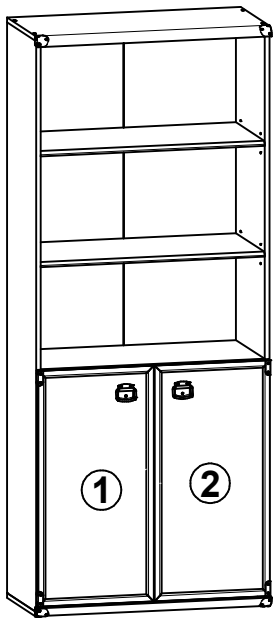
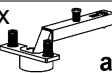



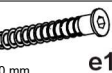
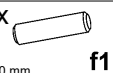

A	B	C	D	
1	S31-013	792	396	3/3
2	S31-014	792	396	3/3
3	S31-113	1916	370	1/3
4	S31-114	1916	370	1/3
5	S31-207	800	395	2/3
6	S31-211	800	395	2/3
7	S31-305	767	370	1/3
8	S31-306	767	370	1/3
9	S31-307	767	370	1/3
10	S31-901	1942	793	1/3

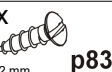

4x  a2	4x  b1	2x  c158	12x  d1 Ø5x17 mm	8x  e1 Ø7x50 mm	12x  f1 Ø8x30 mm	4x  j30 M4x22 mm	4x  k22 Ø15	65x  l1
4x  i27	2x  i28/L	2x  i28/P	16x  p83 Ø3x12 mm	4x  r1 Ø15x12 mm #16	4x  r42	1x  z1 4 mm	1x  n26/l	1x  p38 Ø3.5x16 mm

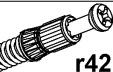
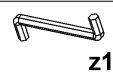
1

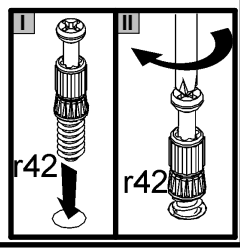
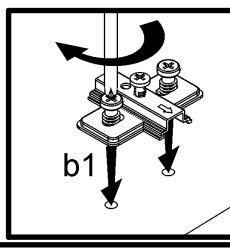
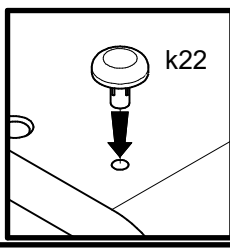
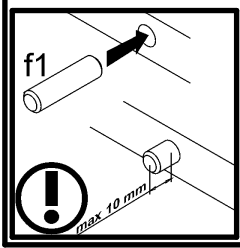
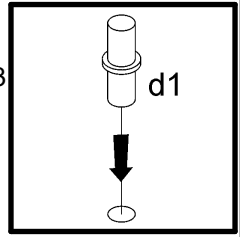
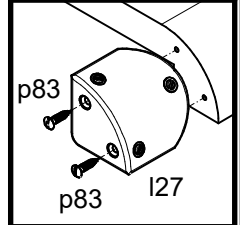
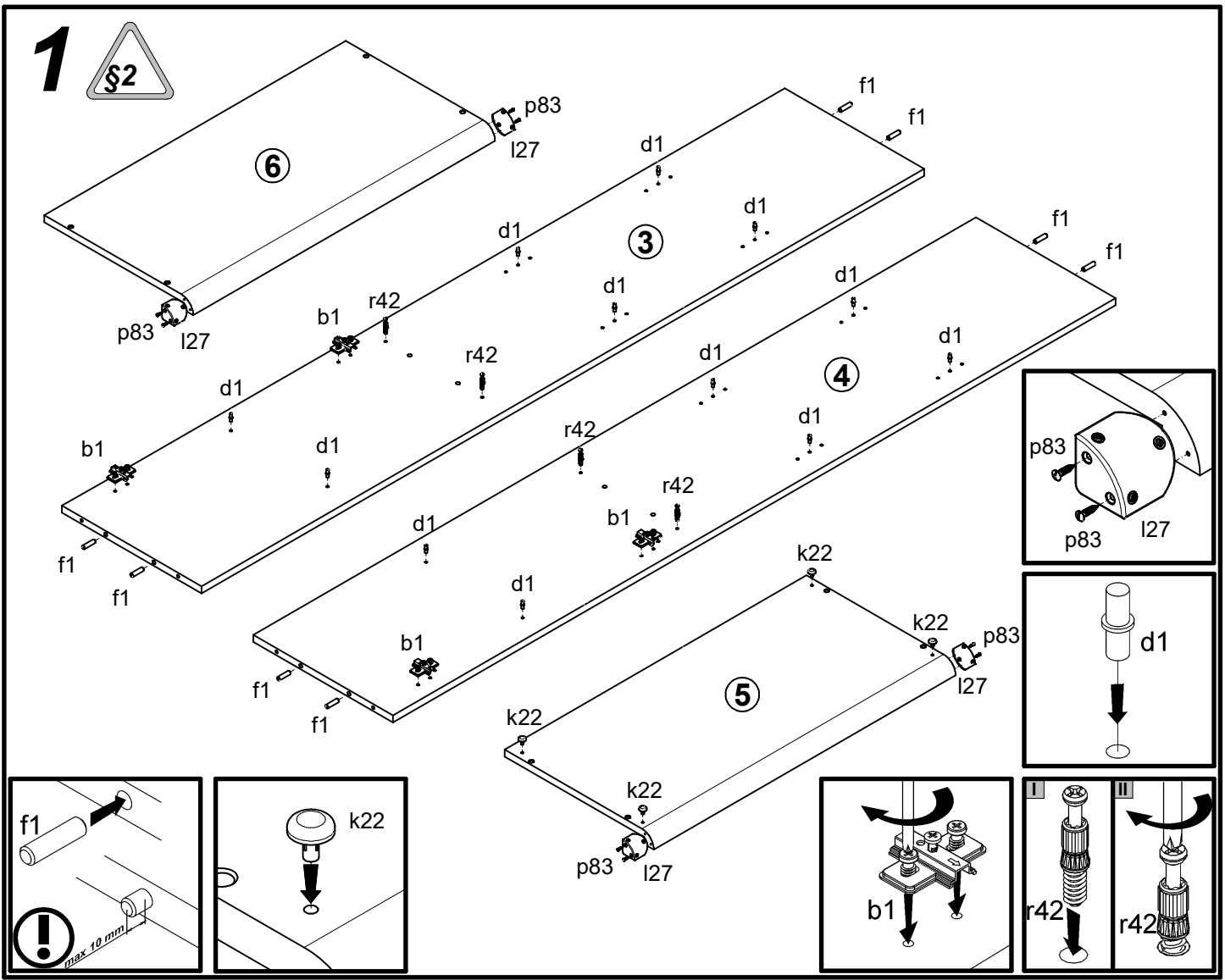

2

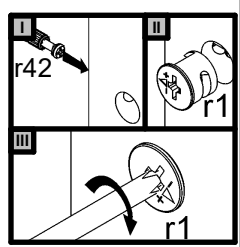
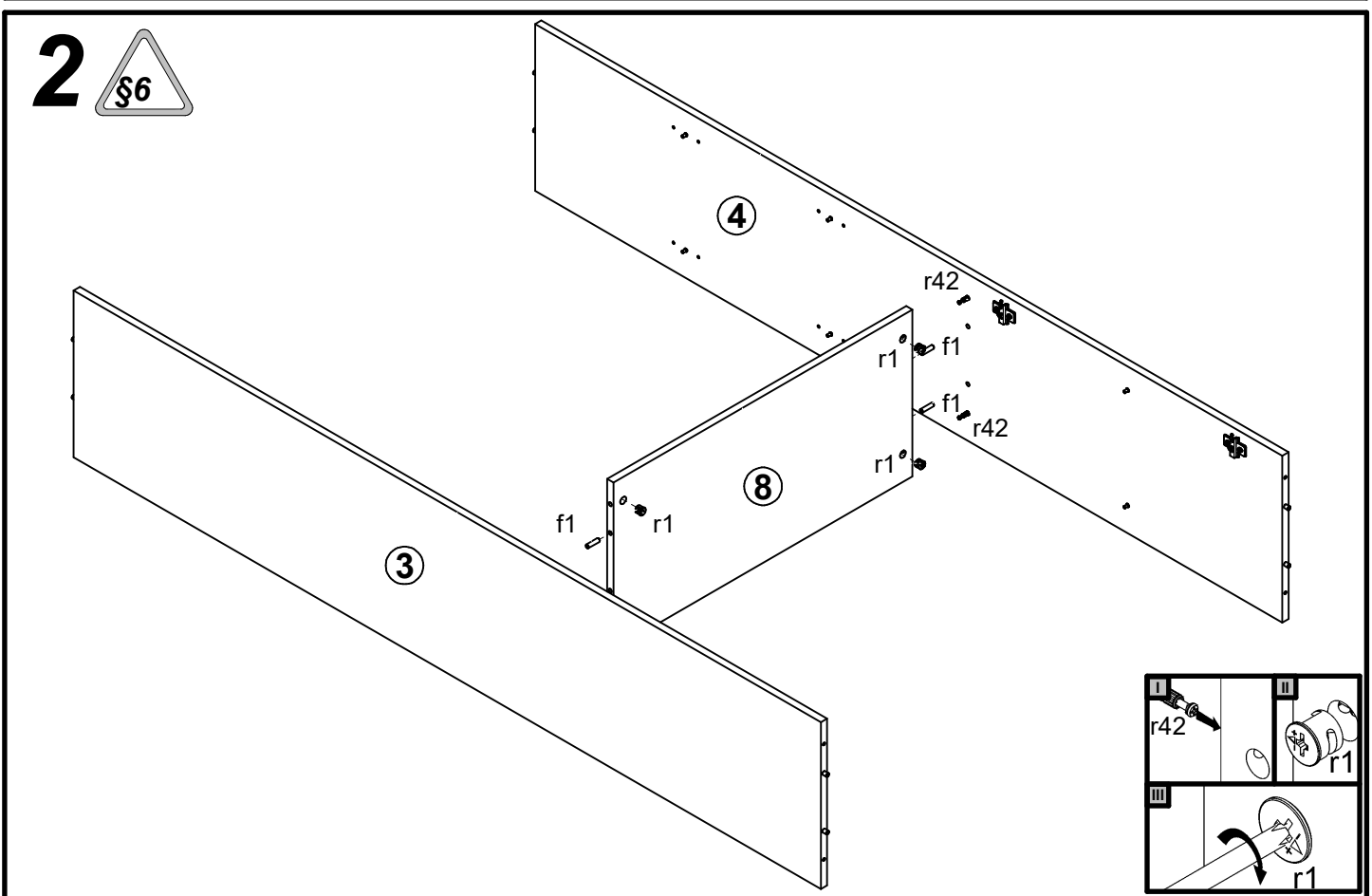

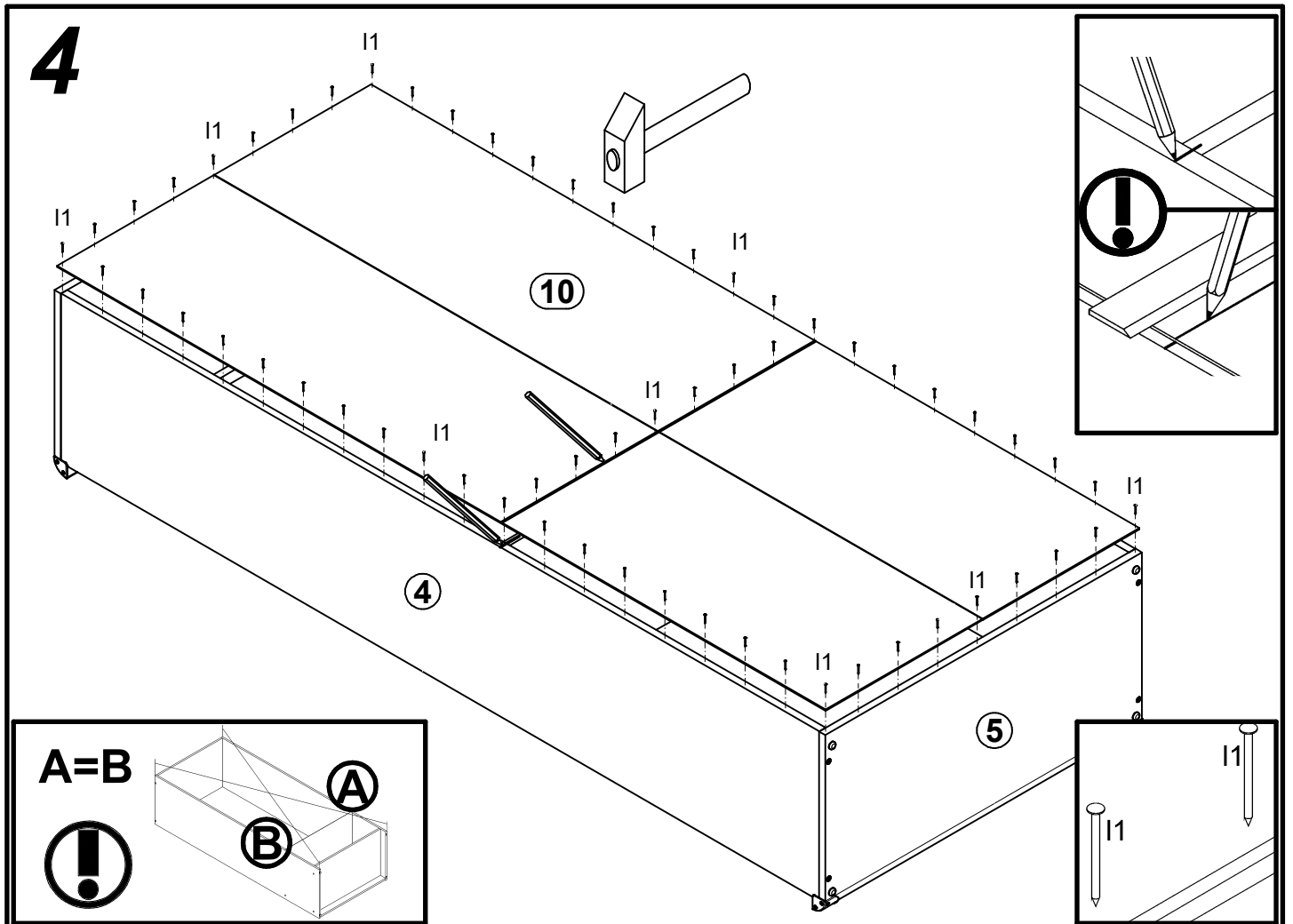
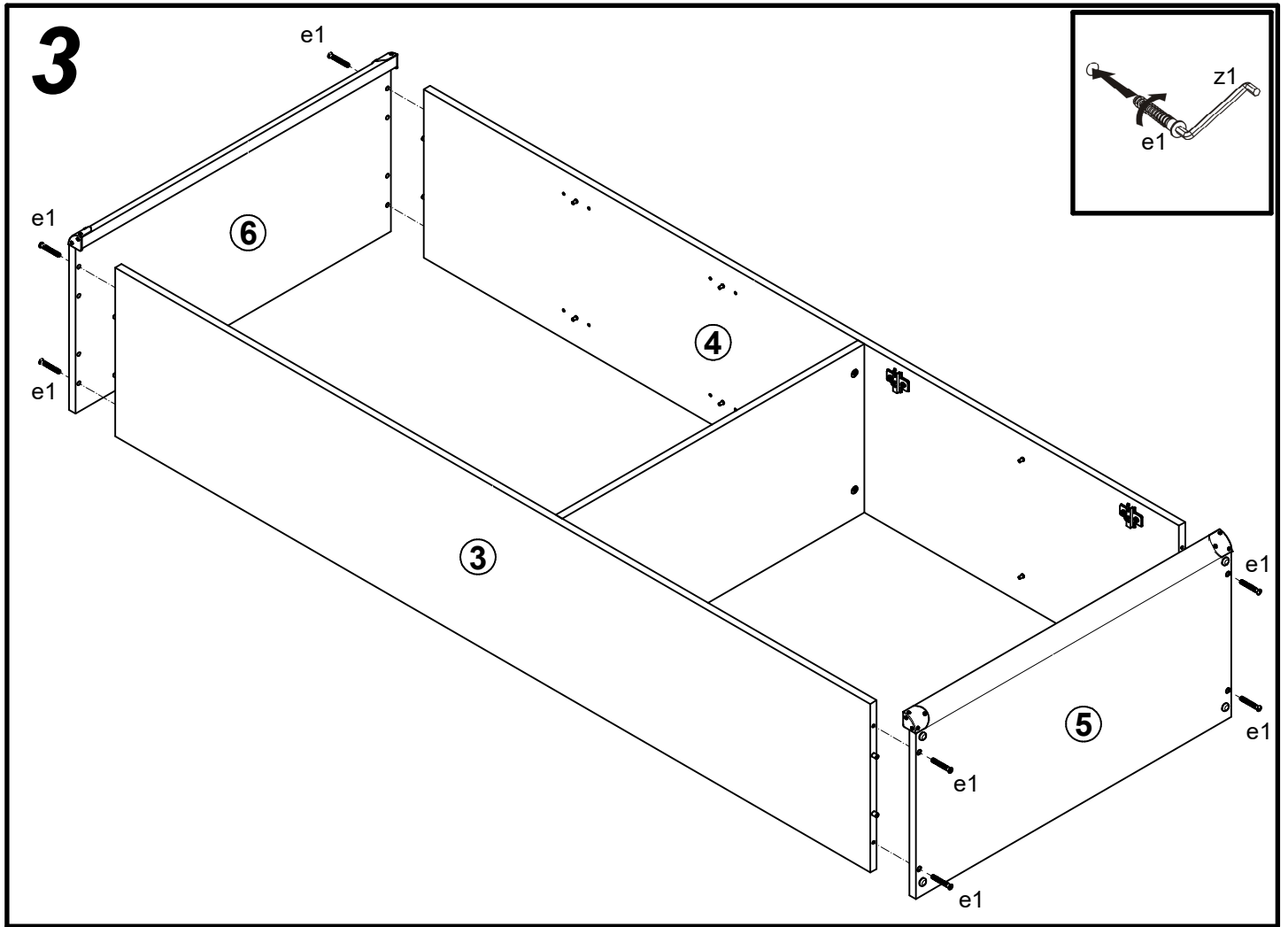

5

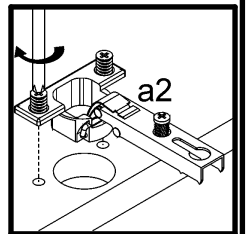
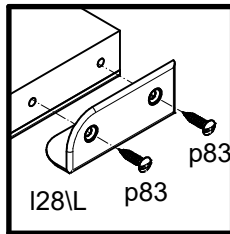
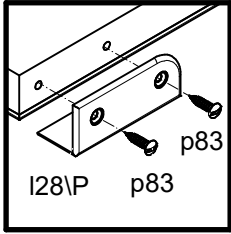
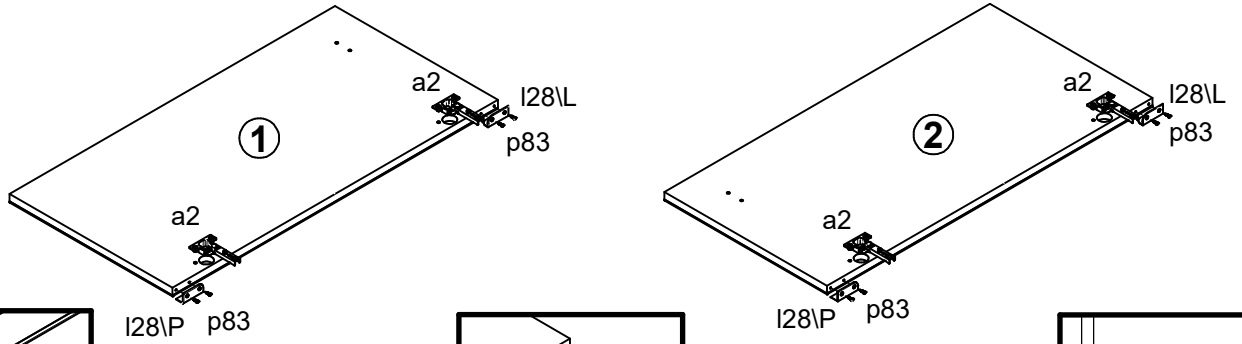

6

